



Tools & Knives



www.ganzo.cn
www.ganzoknife.com



Tools & Knives



ABOUT US

Ganzo company based on the accumulated technical experience of OEM high-end outdoor tools and knives by many years,our team pay more attention to product design,product researching and development,product quality and customer experience.

Concentrate on the production of superior outdoor tools and knives.

And thanks to the support from Ganzo&Firebird fans around the world.

We would like to hear your voice,maybe next production model is named after you.

Serving customers,we are always on the road.

F/G 704 GR CF OR BK



Type of lock: G-lock
Blade material: 440C (+58HRC)
Handle material: G10 or Carbon fiber
Blade length: 85mm
Weight: 140 g

F/G 707



Type of lock: Auto
Blade material: 440C (+58HRC)
Handle material: Stainless steel+Wood
Blade length: 85mm
Weight: 133 g

F/G 708



Type of lock: Liner lock
Blade material: 440C (+58HRC)
Handle material: G10
Blade length: 80mm
Weight: 133 g

F/G 713M



Type of lock: Back lock
Blade material: 440C (+58HRC)
Handle material: G10
Blade length: 80mm
Weight: 104 g

F/G 714



Type of lock: Liner lock
Blade material: 440C (+58HRC)
Handle material: G10
Blade length: 87mm
Weight: 115 g

F/G 720 BK OR GR



Type of lock: G-lock
Blade material: 440C (+58HRC)
Handle material: G10
Blade length: 89mm
Weight: 205 g

F/G 7211 GR BK WD2 GY



Type of lock: Auto
Blade material: 440C (+58HRC)
Handle material: G10 or Wood
Blade length: 85mm
Weight: 135 g

F/G 7212 WD2 BK GR



Type of lock: Auto
Blade material: 440C (+58HRC)
Handle material: G10 or Wood
Blade length: 85mm
Weight: 135 g

F/G 722 GR OR BK



Type of lock: Frame lock
Blade material: 440C (+58HRC)
Handle material: G10
Blade length: 90mm
Weight: 225 g

F/G 723 BK GR OR



Type of lock: Frame lock
Blade material: 440C (+58HRC)
Handle material: G10
Blade length: 95mm
Weight: 180 g

F/G 724M BK OR GR



Type of lock: G-lock
Blade material: 440C (+58HRC)
Handle material: G10
Blade length: 80mm
Weight: 124 g

F/G 727M BK CA



Type of lock: G-lock
Blade material: 440C (+58HRC)
Handle material: G10 or Wood
Blade length: 89mm
Weight: 130 g

F/G 727S BK CA OR CF

New



Type of lock: G-lock
Blade material: 440C (+58HRC)
Handle material: G10
Blade length: 78mm
Weight: 81 g

F/G 7361 BK GR CA WD2 WDI



Type of lock: Auto
Blade material: 440C (+58HRC)
Handle material: G10 or Wood
Blade length: 80mm
Weight: 133 g

F/G 7362 GR CA BK



Type of lock: Auto
Blade material: 440C (+58HRC)
Handle material: G10
Blade length: 80mm
Weight: 133 g

F/G 738 GR OR BK



Type of lock: G-lock
Blade material: 440C (+58HRC)
Handle material: G10
Blade length: 89mm
Weight: 123 g

F/G 7392 BK OR CF



Type of lock: G-lock
Blade material: 440C (+58HRC)
Handle material: G10 or Carbon fiber
Blade length: 87mm
Weight: 134 g

F/G 7392P BK OR



Type of lock: G-lock
Blade material: 440C (+58HRC)
Handle material: G10
Blade length: 87mm
Weight: 134 g

F/G 7393 GR OR BK



Type of lock: G-lock
Blade material: 440C (+58HRC)
Handle material: G10
Blade length: 87mm
Weight: 134 g

F/G 7393P OR BK



Type of lock: G-lock
Blade material: 440C (+58HRC)
Handle material: G10
Blade length: 87mm
Weight: 134 g

F/G 740 OR BK GR



Type of lock: G-lock
Blade material: 440C (+58HRC)
Handle material: G10
Blade length: 95mm
Weight: 155 g

F/G 7412 BK OR GR CF WD2



Type of lock: G-lock
Blade material: 440C (+58HRC)
Handle material: G10 or Carbon fiber or Wood
Blade length: 89mm
Weight: 150 g

F/G 7412P BK OR



Type of lock: G-lock
Blade material: 440C (+58HRC)
Handle material: G10
Blade length: 89mm
Weight: 150 g

F/G 7413 OR BK



Type of lock: G-lock
Blade material: 440C (+58HRC)
Handle material: G10
Blade length: 89mm
Weight: 150 g

F/G 7413P OR BK



Type of lock: G-lock
Blade material: 440C (+58HRC)
Handle material: G10
Blade length: 89mm
Weight: 150 g

F/G 7421 OR GR WD1 BK



Type of lock: Frame lock
Blade material: 440C (+58HRC)
Handle material: G10 or Wood
Blade length: 89mm
Weight: 162 g

F/G 7431 OR GR BK



Type of lock: Frame lock
Blade material: 440C (+58HRC)
Handle material: G10 or Wood
Blade length: 87mm
Weight: 130 g

F/G 7432 BK GR OR



Type of lock: Frame lock
Blade material: 440C (+58HRC)
Handle material: G10
Blade length: 87mm
Weight: 130 g

F/G 7452 BK OR GR CF



Type of lock: G-lock
Blade material: 440C (+58HRC)
Handle material: G10 or Carbon fiber
Blade length: 90mm
Weight: 142 g

F/G 7452P OR BK



Type of lock: G-lock
Blade material: 440C (+58HRC)
Handle material: G10
Blade length: 90mm
Weight: 142 g

F/G 7453 GR OR BK



Type of lock: G-lock
Blade material: 440C (+58HRC)
Handle material: G10
Blade length: 90mm
Weight: 142 g

F/G 7453P OR BK



Type of lock: G-lock
Blade material: 440C (+58HRC)
Handle material: G10
Blade length: 90mm
Weight: 142 g

F/G 7461 GR OR WDI BK



Type of lock: G-lock
Blade material: 440C (+58HRC)
Handle material: G10 or Wood
Blade length: 85mm
Weight: 111 g

F/G 7463RB



Type of lock: G-lock
Blade material: 440C (+58HRC)
Handle material: G10
Blade length: 85mm
Weight: 111 g

F/G 7471 GR WD2 BK



Type of lock: Auto
Blade material: 440C (+58HRC)
Handle material: G10 or Wood
Blade length: 89mm
Weight: 162 g

F/G 7472 BK GR WD2



Type of lock: Auto
Blade material: 440C (+58HRC)
Handle material: G10 or Wood
Blade length: 89mm
Weight: 162 g

F/G 7482 BK OR GR



Type of lock: Auto
Blade material: 440C (+58HRC)
Handle material: G10
Blade length: 89mm
Weight: 134 g

F/G 7491 GR OR BK



Type of lock: Flipper lock
Blade material: 440C (+58HRC)
Handle material: G10
Blade length: 87mm
Weight: 142 g

F/G 7492 BK OR GR



Type of lock: Flipper lock
Blade material: 440C (+58HRC)
Handle material: G10
Blade length: 87mm
Weight: 142 g

F/G 7501 GR OR CF BK



Type of lock: G-lock
Blade material: 440C (+58HRC)
Handle material: G10 or Carbon fiber
Blade length: 89mm
Weight: 130 g

F/G 7503



Type of lock: G-lock
Blade material: 440C (+58HRC)
Handle material: Carbon fiber
Blade length: 89mm
Weight: 130 g

F/G 7531 GR OR CF BK GY



Type of lock: G-lock
Blade material: 440C (+58HRC)
Handle material: G10 or Carbon fiber
Blade length: 89mm
Weight: 126 g

F/G 7533 BK OR CF GR



Type of lock: G-lock
Blade material: 440C (+58HRC)
Handle material: G10 or Carbon fiber
Blade length: 89mm
Weight: 126 g

F/G 753M1 CF OR GR BK



Type of lock: G-lock
Blade material: 440C (+58HRC)
Handle material: G10 or Carbon fiber
Blade length: 77mm
Weight: 81 g

F/G 7542 BK GR CF OR



Type of lock: G-lock
Blade material: 440C (+58HRC)
Handle material: G10 or Carbon fiber
Blade length: 89mm
Weight: 120 g

F/G 7551



New



Type of lock: G-lock
Blade material: 440C (+-58HRC)
Handle material: G10 or Carbon fiber
Blade length: 85mm
Weight: 118 g

F/G 7562



New



Type of lock: G-lock
Blade material: 440C (+-58HRC)
Handle material: G10 or Carbon fiber
Blade length: 89mm
Weight: 126 g

F/G 7563



New



Type of lock: G-lock
Blade material: 440C (+-58HRC)
Handle material: G10 or Carbon fiber
Blade length: 89mm
Weight: 126 g

F/G 759M



New



Type of lock: Back lock
Blade material: 440C (+-58HRC)
Handle material: Nylon glass fiber
Blade length: 75mm
Weight: 67 g

F/G B7601



Bearing

New



Type of lock: G-lock
Blade material: 440C (+-58HRC)
Handle material: G10 or Carbon fiber
Blade length: 87mm
Weight: 120 g

F/G B7603



Bearing

New



Type of lock: G-lock
Blade material: 440C (+-58HRC)
Handle material: G10 or Carbon fiber
Blade length: 87mm
Weight: 120 g

F/G 7611



New



Type of lock: G-lock
Blade material: 440C (+-58HRC)
Handle material: G10 or Carbon fiber
Blade length: 87mm
Weight: 142 g

F/G B762



Bearing

New



Type of lock: G-lock
Blade material: 440C (+-58HRC)
Handle material: G10 or Carbon fiber
Blade length: 89mm
Weight: 105 g

F/G B763



Bearing

New



Type of lock: G-lock
Blade material: 440C (+-58HRC)
Handle material: G10 or Carbon fiber
Blade length: 86mm
Weight: 116 g

F/G B765



Bearing

New



Type of lock: G-lock
Blade material: 440C (+-58HRC)
Handle material: G10 or Carbon fiber
Blade length: 83mm
Weight: 101g

FH11



New



Type of lock: Flipper
Blade material: D2 (+60HRC)
Handle material: G10 or Carbon fiber
Blade length: 87mm
Weight: 112 g

FH13-SS

New



Type of lock: Flipper
Blade material: D2 (+60HRC)
Handle material: Stainless Steel
Blade length: 87mm
Weight: 112 g

FH41



New



Type of lock: Flipper
Blade material: D2 (+60HRC)
Handle material: G10 or Carbon fiber
Blade length: 88mm
Weight: 101g

FH71



New



Type of lock: Flipper
Blade material: D2 (+60HRC)
Handle material: G10 or Carbon fiber
Blade length: 87mm
Weight: 98g

FH921



New



Type of lock: Flipper
Blade material: D2 (+60HRC)
Handle material: G10
Blade length: 86mm
Weight: 113.5g

FH11S



New



Type of lock: Flipper
Blade material: D2 (+60HRC)
Handle material: G10 or Carbon fiber
Blade length: 78mm
Weight: 82 g

FH21



New



Type of lock: Flipper
Blade material: D2 (+60HRC)
Handle material: G10
Blade length: 86mm
Weight: 96.5 g

FH51



New



Type of lock: Flipper
Blade material: D2 (+60HRC)
Handle material: G10
Blade length: 81mm
Weight: 80g

FH81



New



Type of lock: Flipper
Blade material: D2 (+60HRC)
Handle material: G10
Blade length: 87mm
Weight: 133g

Skimen



New



Type of lock: Flipper
Blade material: D2 (+60HRC)
Handle material: G10 or Carbon fiber
Blade length: 85mm
Weight: 120g

FH12-SS

New



Type of lock: Flipper
Blade material: D2 (+60HRC)
Handle material: Stainless Steel
Blade length: 87mm
Weight: 112 g

FH31



New



Type of lock: Flipper
Blade material: D2 (+60HRC)
Handle material: G10 or Carbon fiber
Blade length: 86mm
Weight: 113 g

FH61



New



Type of lock: Flipper
Blade material: D2 (+60HRC)
Handle material: G10 or Carbon fiber
Blade length: 70mm
Weight: 100g

FH91



New



Type of lock: Flipper
Blade material: D2 (+60HRC)
Handle material: G10
Blade length: 88mm
Weight: 119g

F/G 611 BK GR OR



Type of lock: Liner lock
Blade material: 420 (+54HRC)
Handle material: ABS
Blade length: 78mm
Weight: 105 g

F/G 615



Type of lock: Liner lock
Blade material: 420 (+54HRC)
Handle material: ABS
Blade length: 79mm
Weight: 80 g

F/G 617



Type of lock: Liner lock
Blade material: 420 (+54HRC)
Handle material: ABS
Blade length: 80mm
Weight: 105 g

F/G 620G1 BK GR DY



Type of lock: Liner lock
Blade material: 420 (+54HRC)
Handle material: ABS
Blade length: 88mm
Weight: 110 g

F/G 620G2 BK GR



Type of lock: Liner lock
Blade material: 420 (+54HRC)
Handle material: ABS
Blade length: 88mm
Weight: 110 g

F/G 621 OR GY



Type of lock: Liner lock
Blade material: 420 (+54HRC)
Handle material: ABS
Blade length: 80mm
Weight: 105 g

F/G 624M BL RD GR BK



Type of lock: No lock
Blade material: 420 (+54HRC)
Handle material: ABS
Blade length: 40mm
Weight: 22.5 g

F/G 6252 BK GR OR



Type of lock: Liner lock
Blade material: 440 (+55HRC)
Handle material: glass fiber
Blade length: 89mm
Weight: 142 g

F/G 626 BK RD GS BS



Type of lock: Flipper
Blade material: 440 (+54HRC)
Handle material: ABS
Blade length: 96mm
Weight: 125 g

F/G 8012 BK LG DY OR



Blade material: 8CR13 (+58HRC)
Handle material: ABS
Blade length: 115mm
Weight: 356 g

F/G 803 DY OR LG GY



Blade material: 8CR13 (+58HRC)
Handle material: ABS
Blade length: 113mm
Weight: 355 g

F 804



Blade material: 5CR14 (+54HRC)
Handle material: Rubber Plastic
Blade length: 286mm
Weight: 544 g

FH 805



Blade material: 9CR18(+59HRC)
Handle material: G10
Blade length: 85mm
Weight: 155 g

F/G 301

Opened length: 16.5cm
Length in folded state: 10.5cm
Thickness: 1.8cm
Material: 440
Weight: 279g

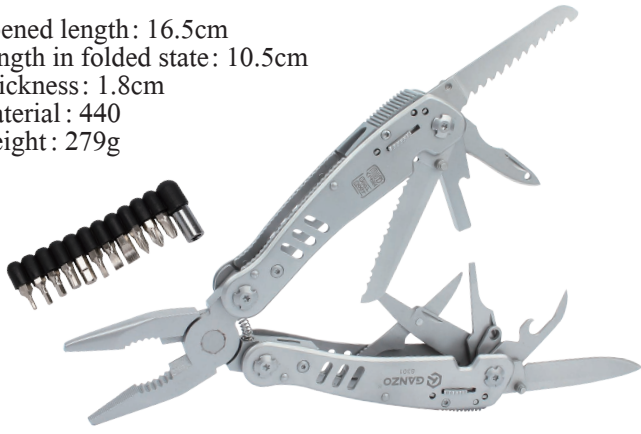

F/G 301B

Opened length: 16.5cm
Length in folded state: 10.5cm
Thickness: 1.8cm
Material: 440
Weight: 282g



F/G 301H

Opened length: 16.5cm
Length in folded state: 10.5cm
Thickness: 1.8cm
Material: 440
Weight: 277g



F/G 302B

Opened length: 16.5cm
Length in folded state: 10.5cm
Thickness: 1.8cm
Material: 440
Weight: 277g



F/G 302H

Opened length: 16.5cm
Length in folded state: 10.5cm
Thickness: 1.8cm
Material: 440
Weight: 278g



F/G 201

Opened length: 16.5cm
Length in folded state: 10.5cm
Thickness: 1.8cm
Material: 440
Weight: 270g

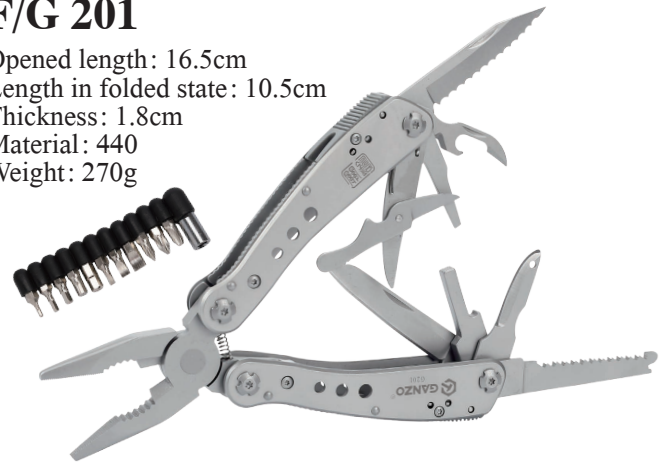

F/G 201B

Opened length: 16.5cm
Length in folded state: 10.5cm
Thickness: 1.8cm
Material: 440
Weight: 275g



F/G 201H

Opened length: 16.5cm
Length in folded state: 10.5cm
Thickness: 1.8cm
Material: 440
Weight: 270g



F/G 202

Opened length: 16.5cm
Length in folded state: 10.5cm
Thickness: 1.7cm
Material: 440
Weight: 251g

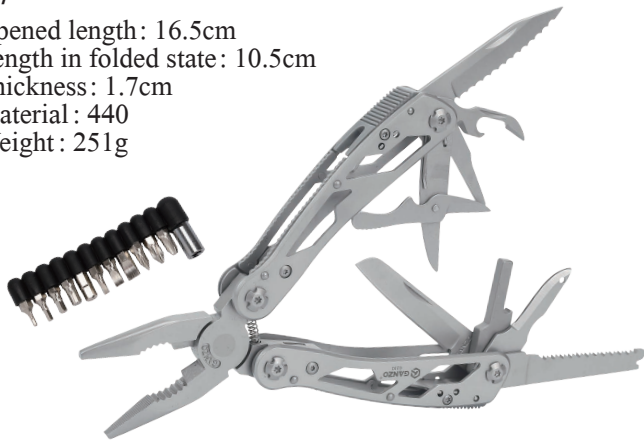

F/G 202B

Opened length: 16.5cm
Length in folded state: 10.5cm
Thickness: 1.7cm
Material: 440
Weight: 254g



F/G 203

Opened length: 16.5cm
Length in folded state: 10.5cm
Thickness: 1.8cm
Material: 440
Weight: 215g



F/G 204

Opened length: 16.5cm
Length in folded state: 10.5cm
Thickness: 1.8cm
Material: 440
Weight: 255g



F/G 101H

Opened length: 16.5cm
Length in folded state: 10.5cm
Thickness: 1.8cm
Material: 420
Weight: 207g



F/G 103

Opened length: 16.5cm
Length in folded state: 10.5cm
Thickness: 1.8cm
Material: 420
Weight: 250g



F/G 104

Opened length: 16.5cm
Length in folded state: 10.5cm
Thickness: 1.7cm
Material: 420
Weight: 231g



F/G 105

Opened length: 16.5cm
Length in folded state: 10.5cm
Thickness: 1.8cm
Material: 420
Weight: 212g



F/G 106

Opened length: 16.5cm
Length in folded state: 10.5cm
Thickness: 2cm
Material: 420
Weight: 209g



F/G 107

Opened length: 16.5cm
Length in folded state: 10.5cm
Thickness: 1.8cm
Material: 420
Weight: 210g



F/G 109

Opened length: 16cm
Length in folded state: 10cm
Thickness: 2cm
Material: 420
Weight: 212g



F/G 112

Opened length: 16.5cm
Length in folded state: 10.5cm
Thickness: 1.8cm
Material: 420
Weight: 262g



F/G 101S

Opened length: 11cm
Length in folded state: 8.2cm
Thickness: 1.5cm
Material: 420
Weight: 83g



F/G 104S

Opened length: 11cm
Length in folded state: 8.2cm
Thickness: 1.5cm
Material: 420
Weight: 87g



FSA01-YE

Set of three elements :Axe,Saw and Flint;
The stainless steel 3CR13 is used;
Material of the axe handle - nylon with fiberglass;
Material of saw handle - plastic ABS;
Axe is equipped with a plastic case on the cutting edge;
Set weight is 860 grams;
The total length of the saw - 30cm;
The total length of the axe - 34.7cm;
Cutting edge width - 8cm;
Flint size - 7cm.



FSA02-YE

Set of three elements :Axe,Saw and Flint;
The stainless steel 3CR13 is used;
Material of the axe handle -Reinforced nylon glass fiber /rubber ;
Material of saw handle - plastic ABS;
Axe is equipped with a plastic case on the cutting edge;
Set weight is 990 grams;
The total length of the saw - 23.8cm;
The total length of the axe - 68.5cm;
Cutting edge width -13.5cm;
Flint size - 5.6cm.



Knife Bag - 2



Whistle



Fire Starter

Diamond

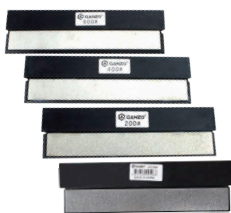

Model : 100/200/400/600

Sharpening Stone



Model : 120/320/600/1500

TOUCH PRO STEEL GTPS

Metal structure throughout;
Sharpening angle is freely adjustable;
Rigid fixation of the blade is possible;
The grinder can be fastened to any smooth surface;
Sharpening function knives of any purpose, scissors,
construction and garden tools;
Fast change of grinding stone is possible.

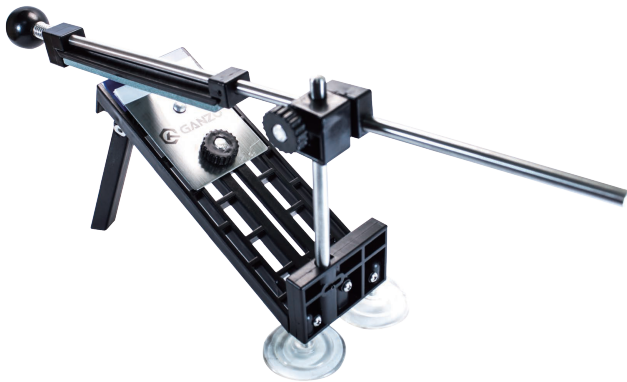

Sharpener 1



Sharpener 2



Sharpener 3



Ganzo Razor Pro



GSA01-YE

Set of three elements: Axe, Saw and Flint;
The stainless steel 3CR13 is used;
Material of the axe handle - nylon with fiberglass;
Material of saw handle— plastic ABS;
Axe is equipped with a plastic case on the cutting edge;
Set weight is 860 grams;
The total length of the saw — 30 cm;
The total length of the axe — 34,7 cm;
Cutting edge width — 8 cm;
Flint size — 7 cm.

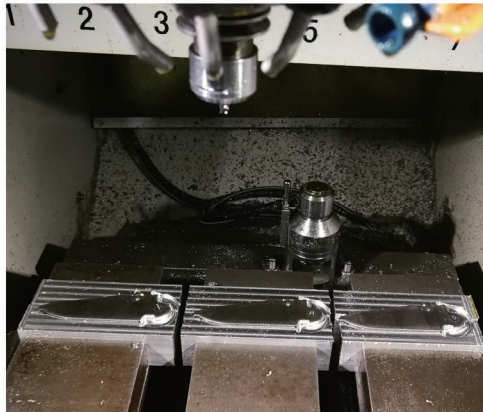
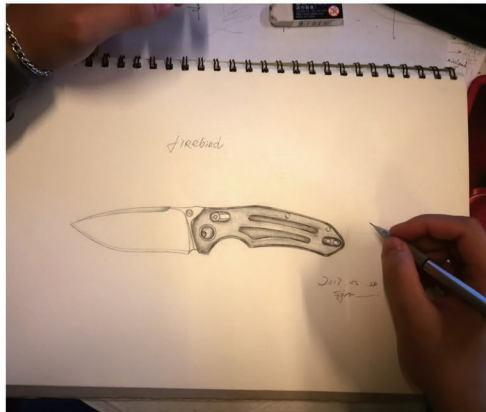



www.facebook.com/ganzoknife
www.instagram.com/ganzoknife

www.ganzo.cn
www.ganzoknife.com